



**FRISENETTE**



LABORATORY  
FILTRATION PRODUCTS  
& CONSUMABLES

## Introduction

We are proud to present this fourth issue of our catalogue with Frisenette products.

Frisenette ApS was founded in 1931 and is a leading manufacturer and distributor of filters, filtration equipment and consumables for laboratory use. Together with our suppliers we strive to assure customer access to the latest developments in laboratory filtration and consumables. This is reflected in our large and diversified product range which meets the requirements in any modern laboratory.

Our products are widely used in the pharmaceutical industry, public health, life science, chemical industry, food and beverage industry, environmental laboratories and the electronics industry. It is our aim to offer our customers highly competitive products and the best service.



*Frisenette ApS is located in Knebel, Denmark*

Beside our own brands, AGF® Filter papers, Q-Max® Syringe filters and MontaMil® Membrane filters, we are promoting products from ADVANTEC Toyo Roshi Kaisha Ltd., GE Healthcare (Whatman), Macherey-Nagel GmbH & Co. KG, Nerbe Plus, Corning Gosselin SAS, Deltalab S.A., Kima s.a.s. and Guangzhou Jet Bio-Filtration.

This catalogue includes our own range of laboratory filtration products: Q-Max® Syringe filters, MontaMil® Membrane filters, Glass- and Quartz fiber filters, Qualitative and Quantitative filter papers, filter holders, pH papers, pH strips and other paper based products.

In the catalogue you will find basic technical information for each product type. If you need any further information please do not hesitate to contact us or your local supplier of our products.



# Table of Contents

Syringe Filters	<b>6</b>
Vent Filters	<b>15</b>
Centrifuge Filters	<b>16</b>
Membrane Filters	<b>18</b>
Filter Cassettes	<b>27</b>
Qualitative Filter Papers	<b>28</b>
Quantitative Filter Papers	<b>29</b>
Glass Fiber Filters	<b>30</b>
Quartz Fiber Filters	<b>31</b>
Filter Holders	<b>32</b>
Extraction Thimbles	<b>34</b>
Lens & Weighing Papers – Milk Filters	<b>35</b>
Seed Testing Papers	<b>36</b>
pH Test	<b>37</b>

## Q-Max<sup>®</sup> RR Syringe Filters

### Q-Max<sup>®</sup> RR Syringe Filters

- This second generation of **Q-Max<sup>®</sup>** syringe filters, **Q-Max<sup>®</sup> RR**, consists of 13 mm and 25 mm filters with a choice of seven different built-in filtration media.
- Choose between six membrane types and two types of glass micro fibers (GF).
- Each filtration media type\*, has its own colour code. Pore size (nominal retention for GF) is printed on each filter.
- **Q-Max<sup>®</sup> RR** syringe filters are supplied in plastic jars with 100 pcs. and in bulk packed boxes with 500 pcs.
- All **Q-Max<sup>®</sup> RR** syringe filters undergoes HPLC extractable tests.
- **Q-Max<sup>®</sup> RR** syringe filters are manufactured in accordance with ISO 9001.

\* Both types of PTFE, hydrophobic and hydrophilic, have the same colour.



### Specifications

	Q-Max <sup>®</sup> RR 13	Q-Max <sup>®</sup> RR 25
Housing material	Polypropylene	Polypropylene
Filtration area [cm <sup>2</sup> ]	0.92	2.98
Hold-up volume [μl]	<10	<30
Max. operating temp [°C]	50	50
Max. operating pressure [bar]	6	6
Recommended sample volume [ml]	<10	<50
Connections [inlet/outlet]	Female luer lock/male luer	Female luer lock/male luer



## Q-Max® RR NY

Nylon – naturally hydrophilic and mechanically strong membrane type with a low level of extractables. Suitable for filtration of aqueous and solvent based samples which makes this type ideal and a good choice for filtration of HPLC samples.



Size [mm]	Pore Size [µm]	Packing [pcs.]	Cat. No.
13	0.22	100	13NY022-100
13	0.22	500	13NY022-500
13	0.45	100	13NY045-100
13	0.45	500	13NY045-500

Size [mm]	Pore Size [µm]	Packing [pcs.]	Cat. No.
25	0.22	100	25NY022-100
25	0.22	500	25NY022-500
25	0.45	100	25NY045-100
25	0.45	500	25NY045-500

## Q-Max® RR CA

Cellulose Acetate membrane – ideal for filtration of aqueous based liquids, most alcohols and liquids containing proteins. CA membranes are considered as being the lowest protein binding membrane type available.



Size [mm]	Pore Size [µm]	Packing [pcs.]	Cat. No.
13	0.22	100	13CA022-100
13	0.22	500	13CA022-500
13	0.45	100	13CA045-100
13	0.45	500	13CA045-500

Size [mm]	Pore Size [µm]	Packing [pcs.]	Cat. No.
25	0.22	100	25CA022-100
25	0.22	500	25CA022-500
25	0.45	100	25CA045-100
25	0.45	500	25CA045-500

## Q-Max® RR PES

PES – Polyethersulphone membrane is a naturally hydrophilic membrane type and is among the most porous types available. Furthermore, this type is asymmetrical, which means that the pores are larger on the inlet side which gives a high throughput. It is ideal for filtration of aqueous based samples and has a low protein binding. PES is also recommended for ion chromatography.



Size [mm]	Pore Size [µm]	Packing [pcs.]	Cat. No.
13	0.22	100	13PE022-100
13	0.22	500	13PE022-500
13	0.45	100	13PE045-100
13	0.45	500	13PE045-500

Size [mm]	Pore Size [µm]	Packing [pcs.]	Cat. No.
25	0.22	100	25PE022-100
25	0.22	500	25PE022-500
25	0.45	100	25PE045-100
25	0.45	500	25PE045-500

# SYRINGE FILTERS

## Q-Max® RR Syringe Filters

### Q-Max® RR PVDF

Polyvinylidene Difluoride membrane – slightly hydrophobic. Good solvent and acid resistance makes this type suitable for filtration of HPLC samples. Not recommended for filtration of aqueous based samples.



Size [mm]	Pore Size [µm]	Packing [pcs.]	Cat. No.
13	0.22	100	13PV022-100
13	0.22	500	13PV022-500
13	0.45	100	13PV045-100
13	0.45	500	13PV045-500

Size [mm]	Pore Size [µm]	Packing [pcs.]	Cat. No.
25	0.22	100	25PV022-100
25	0.22	500	25PV022-500
25	0.45	100	25PV045-100
25	0.45	500	25PV045-500

### Q-Max® RR GF

Glass micro fibers. The choice for final filtration of samples with a large number of particles or as a pre-filter for syringe filters with built-in membranes.



Size [mm]	Nominal Pore Size [µm]	Packing [pcs.]	Cat. No.
13	0.7	100	13GF070-100
13	0.7	500	13GF070-500
13	1.0	100	13GF100-100
13	1.0	500	13GF100-500

Size [mm]	Nominal Pore Size [µm]	Packing [pcs.]	Cat. No.
25	0.7	100	25GF070-100
25	0.7	500	25GF070-500
25	1.0	100	25GF100-100
25	1.0	500	25GF100-500

## Q-Max® RR Syringe Filters

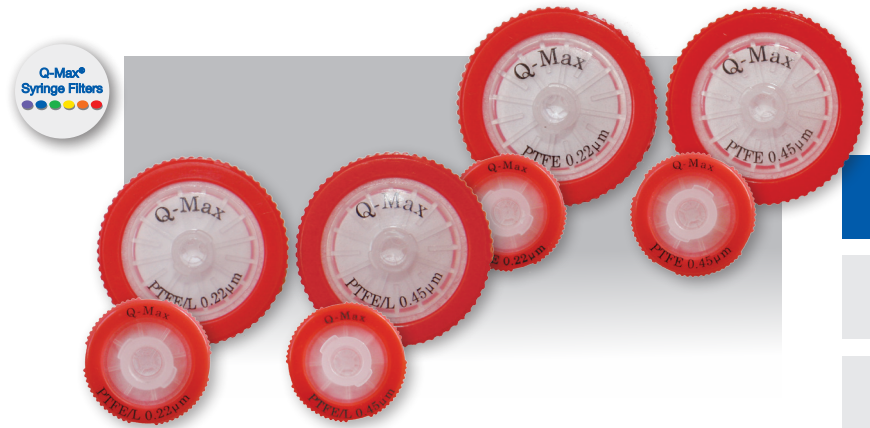

### Q-Max® RR PTFE

Polytetrafluoroethylene membrane – naturally **hydrophobic** with excellent resistance against solvents, bases and acids.

Size [mm]	Pore Size [µm]	Packing [pcs.]	Cat. No.
13	0.22	100	13PT022-100
13	0.22	500	13PT022-500
13	0.45	100	13PT045-100
13	0.45	500	13PT045-500

Size [mm]	Pore Size [µm]	Packing [pcs.]	Cat. No.
25	0.22	100	25PT022-100
25	0.22	500	25PT022-500
25	0.45	100	25PT045-100
25	0.45	500	25PT045-500

### Q-Max® RR PTFE/L

**Hydrophilic** PTFE membrane with solvent, base and acid resistance like the hydrophobic type, but also suitable for filtration of aqueous samples which makes this type extremely versatile.

Size [mm]	Pore Size [µm]	Packing [pcs.]	Cat. No.
13	0.22	100	13PL022-100
13	0.22	500	13PL022-500
13	0.45	100	13PL045-100
13	0.45	500	13PL045-500

Size [mm]	Pore Size [µm]	Packing [pcs.]	Cat. No.
25	0.22	100	25PL022-100
25	0.22	500	25PL022-500
25	0.45	100	25PL045-100
25	0.45	500	25PL045-500

# SYRINGE FILTERS

## Q-Max<sup>®</sup> GPF Syringe Filters

### Q-Max<sup>®</sup> GPF Syringe Filters

- **Q-Max<sup>®</sup> GPF** 25 mm syringe filters with built-in glass fiber pre-filters are specially designed to filter samples with many particles.
- Available with Cellulose Acetate membranes for aqueous based liquids and Nylon membranes for solvents and/or aqueous based liquids.
- Pore sizes 0.22  $\mu\text{m}$  and 0.45  $\mu\text{m}$ .
- Available in boxes of 100 pcs. or bulk packed in boxes of 500 pcs.



### Specifications

	Q-Max <sup>®</sup> GPF
Housing material	Polypropylene
Filtration area [cm <sup>2</sup> ]	2.98
Hold-up volume [ $\mu\text{l}$ ]	<30
Max. operating temp [°C]	50
Max. operating pressure [bar]	6
Recommended sample volume [ml]	<100
Connections [inlet/outlet]	Female luer lock/male luer

### Ordering information

#### With Cellulose Acetate membranes

Pore Size [ $\mu\text{m}$ ]	Packing [pcs.]	Cat. No.
0.22	100	25CAGF022-100
0.22	500	25CAGF022-500
0.45	100	25CAGF045-100
0.45	500	25CAGF045-500

#### With Nylon membranes

Pore Size [ $\mu\text{m}$ ]	Packing [pcs.]	Cat. No.
0.22	100	25NYGF022-100
0.22	500	25NYGF022-500
0.45	100	25NYGF045-100
0.45	500	25NYGF045-500

## Q-Max® CA-LS & Q-Max® CA-Plus Sterile Syringe Filters

### Q-Max® CA-LS

- Sterile 25 mm syringe filters with low protein binding Cellulose Acetate membranes.
- Main application is sterile filtration of aqueous solutions in volumes up to approx. 50 ml.
- Available pore sizes are 0.22 µm and 0.45 µm.
- Q-Max® CA-LS syringe filters are sterilized by radiation and are manufactured in accordance with ISO 9001.

### Q-Max® CA-Plus

- Sterile 25 mm syringe filters with low protein binding Cellulose Acetate membranes and built-in glass fiber pre-filter.
- Main application is sterile filtration of aqueous solutions in volumes up to approx. 100 ml.
- Available pore sizes are 0.22 µm and 0.45 µm.
- Q-Max® CA-Plus syringe filters are sterilized by radiation and are manufactured in accordance with ISO 9001.



### Specifications

	Q-Max® CA-LS	Q-Max® CA-Plus
Housing material	Polypropylene	Polypropylene
Filtration area [cm <sup>2</sup> ]	2.98	2.98
Hold-up volume [µl]	<30	<30
Max. operating temp [°C]	50	50
Max. operating pressure [bar]	6	6
Recommended sample volume [ml]	<50	<100
Connections [inlet/outlet]	Female luer lock/male luer	Female luer lock/male luer

### Ordering information

#### Q-Max® CA-LS

Pore Size [µm]	Packing [pcs.]	Cat. No.
0.22	100	CALS2502100S
0.45	100	CALS2504100S

#### Q-Max® CA-Plus

Pore Size [µm]	Packing [pcs.]	Cat. No.
0.22	100	CAPS2502100S
0.45	100	CAPS2504100S

# SYRINGE FILTERS

## Q-Max<sup>®</sup> PES Sterile Syringe Filters

### Q-Max<sup>®</sup> PES

Q-Max<sup>®</sup> PES sterile 25 mm syringe filters with low protein binding Polyethersulfone (PES) membranes.

- Main application is sterile filtration of aqueous solutions in volumes up to approx. 50 ml.
- Available pore sizes are 0.22  $\mu\text{m}$  and 0.45  $\mu\text{m}$ .
- Q-Max<sup>®</sup> PES syringe filters are sterilized by radiation and are manufactured in accordance with ISO 9001.



### Specifications

	Q-Max <sup>®</sup> PES
Housing material	Polypropylene
Filtration area [cm <sup>2</sup> ]	2.98
Hold-up volume [ $\mu\text{l}$ ]	<30
Max. operating temp [°C]	90
Max. operating pressure [bar]	6.5
Sample volume [ml]	<50
Connections [inlet/outlet]	Female luer lock/male luer

### Ordering information

Pore Size [ $\mu\text{m}$ ]	Packing [pcs.]	Cat. No.
0.22	100	PES2502100S
0.45	100	PES2504100S



## Q-Max® CA and CA-Plus Syringe Filters

Q-Max® 30 mm CA syringe filter with a filtration area which is approximately 50% larger than in standard 25 mm Q-Max® syringe filters.

Available with Cellulose Acetate membrane which is ideal for filtration of aqueous based liquids and some alcohols.

### Q-Max® 30 mm CA

- Pore size 0.45 µm
- Available in packs of 100 pcs. and in bulk packs of 500 pcs.

### Q-Max® 30 mm CA-Plus

- Built-in glass fiber pre-filters increases the total throughput.
- Pore size 0,22 and 0.45 µm (membrane)
- Available in packs of 100 pcs.



### Specifications

	Q-Max® 30 mm CA	Q-Max® 30 mm CA-Plus
Housing material	Polypropylene	Polypropylene
Filtration area [cm <sup>2</sup> ]	4.6	4.9
Hold-up volume [µl]	<100	<150
Max. operating pressure [bar]	5	6
Connections [inlet/outlet]	Female luer lock/male luer	Female luer lock/male luer

### Ordering information

#### Q-Max® 30 mm CA

Packing [pcs.]	Cat. No.
100	CA30045-100
500	CA30045-500

#### Q-Max® 30 mm CA-Plus

Pore size (µm)	Packing [pcs.]	Cat. No.
0.22	100	30CAGF022-100
0.45	100	30CAGF045-100

# SYRINGE FILTERS

## Q-Max® 4 mm Syringe Filters

- For volumes <1 ml
- Low hold up volume
- Six different membrane materials
- Pore sizes 0.22 and 0.45 µm
- Packings of 200 pcs.



Specifications	
Housing material	Polypropylene
Filtration area [cm <sup>2</sup> ]	0.125
Hold-up volume [µl]	<5
Max. operating pressure [bar]	6
Recommended sample volume [ml]	<1
Connections [inlet/outlet]	Female luer lock/Male luer

### Membrane Types

<b>Cellulose Acetate</b>	Hydrophilic low protein binding membrane. Suitable for aqueous solutions and most alcohols.
<b>Nylon</b>	Hydrophilic and versatile membrane. For aqueous and most solvent based solutions e.g. Methanol and Acetonitrile.
<b>Polyethersulfone</b>	Hydrophilic low protein binding membrane. For aqueous and solvent based solutions. Broad pH resistance.
<b>PVDF</b>	Hydrophobic membrane suitable for filtration of solvents and some acids. Not recommended for filtration of water samples.
<b>PTFE, hydrophobic</b>	Suitable for filtration of strong solvents, acids and bases. Not recommended for filtration of water samples.
<b>PTFE, hydrophilic</b>	Very versatile membrane type. Used for filtration of water, solvents, acids and bases.

### Ordering information

Membrane	Pore size [µm]	Cat. No.
Cellulose Acetate	0.22	4CA022-200
Cellulose Acetate	0.45	4CA045-200
Nylon	0.22	4NY022-200
Nylon	0.45	4NY045-200
Polyethersulfone	0.22	4PE022-200
Polyethersulfone	0.45	4PE045-200
PVDF	0.22	4PV022-200
PVDF	0.45	4PV045-200
PTFE hydrophobic	0.22	4PT022-200
PTFE hydrophobic	0.45	4PT045-200
PTFE hydrophilic	0.22	4PL022-200
PTFE hydrophilic	0.45	4PL045-200

## 50 mm Vent Filter

### Applications

- Sterile venting of vessels e.g. carboys, fermenters etc.
- In-line sterilization of and particulate removal from air and gasses
- Autoclave venting
- Water trap
- Filtration of gas for incubators
- Filtration of non-aqueous fluids



### Specifications

50 mm Vent Filter	
Filter Media	Hydrophobic PTFE reinforced with polypropylene
Pore Size [µm]	0.22 or 0.45
Housing	Polypropylene
Connections	6-12 mm stepped hose barb
Filter area [cm <sup>2</sup> ]	19.6
Air flow rate 0.20 µm	27 L/min at 1 bar
Air flow rate 0.45 µm	32 L/min at 1 bar
Housing diameter [mm]	63
Housing length [mm]	53
Max. pressure	3.5 bar (approx. 50 psi)
Autoclavable	up to 10 times – 121°C for 20 min.

### Ordering information

Pore Size [µm]		Packing [pcs.]	Cat. No.
0.22	Non-sterile	20	50PT022-20
0.22	Sterile	20	50PT022S-20
0.45	Non-sterile	20	50PT045-20
0.45	Sterile	20	50PT045S-20

# CENTRIFUGE FILTERS

## Micro-, Midi- and Maxi-Spin

- Made of polypropylene.
- Maxi-Spin with screw cap made of high density polyethylene.
- Volumes are max. volumes.
- Working volumes should be less than stated.
- All types are available with eight types of micro-filtration membranes with two pore sizes.



Micro-Spin	Midi-Spin	Maxi-Spin
Hold-up volume: <math><5\ \mu\text{l}</math>	Hold-up volume: <math><10\ \mu\text{l}</math>	Hold-up volume: <math><20\ \mu\text{l}</math>
Max. centrifugation: 10,000 G	Max. centrifugation: 5,000 G	Max. centrifugation: 2,500 G
900 $\mu\text{l}$ filter insert and 2 ml tube with hinged cap	5 ml filter insert and 7 ml tube with hinged cap	25 ml filter insert and 50 ml tube with screw cap

## Membrane Types

<b>Nylon</b>	Naturally hydrophilic type with broad solvent resistance. Can also be used for filtration of aqueous samples (pH 3-10) and for commonly used chemicals e.g. Methanol and Acetonitrile.
<b>Polyethersulfone (PES)</b>	Hydrophilic and low protein binding type. Resists pH 1-14.
<b>PVDF</b>	Hydrophilic and low protein binding membrane type. Suitable for both solvent and aqueous liquids. Acid resistant.
<b>Regenerated Cellulose (RC)</b>	Hydrophilic and low protein binding membrane type. Suitable for both solvent and aqueous liquids.
<b>PTFE</b>	Hydrophobic membrane. Resists strong solvents, acids and bases. Not suitable for aqueous samples.
<b>Polypropylene (PP)</b>	Hydrophobic and solvent resistant membrane. Ideal for filtration of samples prior to ion-chromatography.
<b>Cellulose Acetate (CA)</b>	Hydrophilic and low protein binding. For aqueous samples. Also resistant to some alcohols.
<b>Nitro Cellulose (NC)</b>	Hydrophilic (wetting agent added) membrane type. For aqueous samples. Binds proteins.

## Micro-Spin

100 pcs. per pack



Membrane	Pore size [μm]	Cat. No.
Nylon	0.2	CINY02
	0.45	CINY45
PES	0.2	CIPE02
	0.45	CIPE45
PVDF	0.2	CIPV02
	0.45	CIPV45
RC	0.2	CIRC02
	0.45	CIRC45
PTFE	0.2	CIPT02
	0.45	CIPT45
PP	0.2	CIPP02
	0.45	CIPP45
CA	0.2	CICA02
	0.45	CICA45
NC	0.2	CINC02
	0.45	CINC45

## Midi-Spin

25 pcs. per pack



Membrane	Pore size [μm]	Cat. No.
Nylon	0.2	BNY02
	0.45	BNY45
PES	0.2	BPE02
	0.45	BPE45
PVDF	0.2	BPV02
	0.45	BPV45
RC	0.2	BRC02
	0.45	BRC45
PTFE	0.2	BPT02
	0.45	BPT45
PP	0.2	BPP02
	0.45	BPP45
CA	0.2	BCA02
	0.45	BCA45
NC	0.2	BNC02
	0.45	BNC45

## Maxi-Spin

50 pcs. per pack



Membrane	Pore size [μm]	Cat. No.
Nylon	0.2	XNY02
	0.45	XNY45
PES	0.2	XPE02
	0.45	XPE45
PVDF	0.2	XPV02
	0.45	XPV45
RC	0.2	XRC02
	0.45	XRC45
PTFE	0.2	XPT02
	0.45	XPT45
PP	0.2	XPP02
	0.45	XPP45
CA	0.2	XCA02
	0.45	XCA45
NC	0.2	XNC02
	0.45	XNC45



# MEMBRANE FILTERS

## MontaMil® CA Membrane Filters

- MontaMil® Cellulose Acetate (CA) membrane filters are made from pure cellulose acetate modified to be the lowest binding filter available.
- The extremely low binding characteristics provide the highest throughput when filtering solutions containing proteins.
- CA is considered as being the lowest protein binding membrane type available.
- CA membrane filters are relative strong and contain only a small amount of aqueous extractables.
- Diameters 25 mm and 47 mm.  
Two pore sizes available.
- Autoclavable.



### Features

- Lowest binding material available
- High throughput
- Strong and dimension stable
- Uniform pores

### Applications

- Filtration and sterilization of protein and enzyme solutions
- Tissue culture media sterilization
- General filtration of aqueous solutions
- Filtration of most alcohols

### Specifications

Pore Size [µm]	Bubble Point [bar]	Water Flow Rate [ml/min/cm <sup>2</sup> ]	Air Flow Rate [L/min./cm <sup>2</sup> ]
0.22	4.0	18.5	2
0.45	3.1	40	4

### Ordering information

Pore Size [µm]	Diameter [mm]	Packing [pcs.]	Cat. No.
0.22	25	100	CA025022
0.22	47	100	CA047022
0.45	25	100	CA025045
0.45	47	100	CA047045



## MontaMil® MCE Membrane Filters

- Mixed Cellulose Ester (MCE) is a mixture of Cellulose Nitrate and Cellulose Acetate.
- By adding Cellulose Acetate the surface of the membrane becomes smoother and more uniform than membranes made of pure Cellulose Nitrate.
- MCE membrane filters are one of the most porous membrane types available.
- Available as plain white.
- Diameters 25 mm and 47 mm.  
Eight pore sizes available.
- Autoclavable.



### Features

- High porosity
- High purity
- Biological inert

### Applications

- Clarification and sterilization of aqueous liquids
- Particle analysis
- Air analysis

### Specifications

Pore Size [µm]	Bubble Point [bar]	Water Flow Rate [ml/min./cm <sup>2</sup> ]	Air Flow Rate [L/min./cm <sup>2</sup> ]
0.22	3.62	19	2
0.45	2.23	60	5
0.65	1.18	135	9
0.8	0.95	180	15
1.2	0.77	270	20
3	0.69	320	28
5	0.56	560	30
8	0.40	600	63

### Ordering information

Pore Size [µm]	Diameter [mm]	Packing [pcs.]	Cat. No.	Pore Size [µm]	Diameter [mm]	Packing [pcs.]	Cat. No.
0.22	25	100	MCE025022	1.2	25	100	MCE025120
0.22	47	100	MCE047022	1.2	47	100	MCE047120
0.45	25	100	MCE025045	3	25	100	MCE025300
0.45	47	100	MCE047045	3	47	100	MCE047300
0.65	25	100	MCE025065	5	25	100	MCE025500
0.65	47	100	MCE047065	5	47	100	MCE047500
0.8	25	100	MCE025080	8	25	100	MCE025800
0.8	47	100	MCE047080	8	47	100	MCE047800

# MEMBRANE FILTERS

## MontaMil® Nylon Membrane Filters

- MontaMil® Nylon membranes are naturally hydrophilic and will only release a negligible amount of extractables.
- Versatile – can be used for filtration of both aqueous liquids and most common solvents.
- MontaMil® Nylon membranes are plain white.
- Diameters 25 mm and 47 mm.  
Two pore sizes available.
- Autoclavable.



### Features

- Naturally hydrophilic
- Very strong
- Low level of extractables

### Applications

- HPLC solvent filtration and degassing
- General filtration of solvents

### Specifications

Pore Size [µm]	Bubble Point [bar]	Water Flow Rate [ml/min./cm <sup>2</sup> ]	Air Flow Rate [L/min./cm <sup>2</sup> ]
0.22	3.4	9.9	1.7
0.45	2.0	26.9	3.2

### Ordering information

Pore Size [µm]	Diameter [mm]	Packing [pcs.]	Cat. No.
0.22	25	100	NY025022
0.22	47	100	NY047022
0.45	25	100	NY025045
0.45	47	100	NY047045

## MontaMil® PVDF Membrane Filters

- This type of MontaMil® PVDF is slightly hydrophobic. This means that the liquid to be filtered must contain min. 30% organic solvent to ensure a proper filtration.
- Resistant to common solvents and several acids.
- It is not recommended to filter aqueous liquids with this type.
- Diameter 47 mm. Two pore sizes available.
- Autoclavable.



### Features

- Strong
- Low level of extractables
- Good solvent and acid resistance

### Applications

- Filtration and degassing HPLC mobile phases
- General solvent filtration

### Specifications

Pore Size [µm]	Thickness [µm]	Bubble Point [bar]	Air Flow Rate [ml/min/cm²]	Porosity [%]
0.22	95	0.7 – 1.5	0.18	75 – 80
0.45	95	0.4 – 0.7	0.2	75 – 80

### Ordering information

Pore Size [µm]	Diameter [mm]	Packing [pcs.]	Cat. No.
0.22	47	100	PV047022
0.45	47	100	PV047045

## MontaMil® PVDF-M Membrane Filters

- Hydrophilic PVDF membrane type.
- MontaMil® PVDF-M is a low protein binding membrane.
- Versatile – can be used for filtration of aqueous liquids and most organic solvents. Also resistant to several acids.
- Diameter 47 mm. Two pore sizes available.
- Autoclavable.

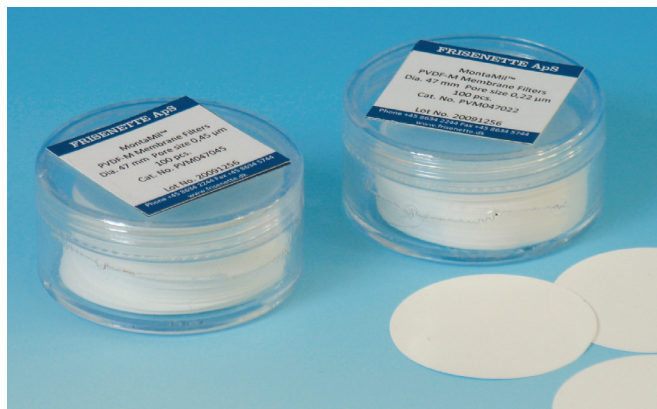

### Features

- Low protein binding
- Broad chemical resistance
- Strong

### Applications

- Filtration and degassing HPLC mobile phases
- Filtration of liquids containing proteins
- General filtration of solvents

### Specifications

Pore Size [µm]	Thickness [µm]	Bubble Point [bar]	Water Flow Rate [ml/min/cm <sup>2</sup> ]	Air Flow Rate [ml/min/cm <sup>2</sup> ]
0.22	125	≥3.45	6.7	2
0.45	125	≥1.55	29	4

### Ordering information

Pore Size [µm]	Diameter [mm]	Packing [pcs.]	Cat. No.
0.22	47	100	PVM047022
0.45	47	100	PVM047045

## MontaMil® Plus Polycarbonate Membrane Filters

- Made from a thin film with precise cylindrical pores.
- Higher pore density compared with traditional polycarbonate membrane filters.
- Narrow pore size distribution
- Very smooth – all particles will be retained on the surface.
- Ideal for microscopy applications.
- Autoclavable.
- Available as translucent and black\*.

\*) Black membranes do not resist all types of immersion oils.  
It is advised to test before use. E.g. Cargille immersion oil TYPE-A will work.



### Features

- Surface retention
- Precise pore sizes
- Biologically inert
- Non-staining
- Non-hygroscopic

### Applications

- Microbiology
- Microscopy
- Air analysis

### Specifications

Pore Size [µm]	Thickness [µm]	Pore Density [mio./cm <sup>2</sup> ]	Water Flow Rate* [ml/min/cm <sup>2</sup> ]	Air Flow Rate* [l/min/cm <sup>2</sup> ]
0.2	25	500	10	3.5
0.4	25	150	45	8.5
* at 10 PSI 0.8	24	40	90	16.0

### Ordering information

Pore Size [µm]	Diameter [mm]	Colour	Packing [pcs.]	Cat. No.
0.2	25	Black	100	PCB025020
0.2	47	Black	100	PCB047020
0.2	25	White/Translucent	100	PCC025020
0.2	47	White/Translucent	100	PCC047020
0.4	25	White/Translucent	100	PCC025040
0.4	47	White/Translucent	100	PCC047040
0.8	25	White/Translucent	100	PCC025080
0.8	47	White/Translucent	100	PCC047080

# MEMBRANE FILTERS

## MontaMil® Polycarbonate Membrane Filters

- Absolute pore size
- Smooth, thin glass-like surface
- Superior strength
- Low extractables
- Negligible absorption/adsorption
- Available as white (translucent) and black (dark grey)

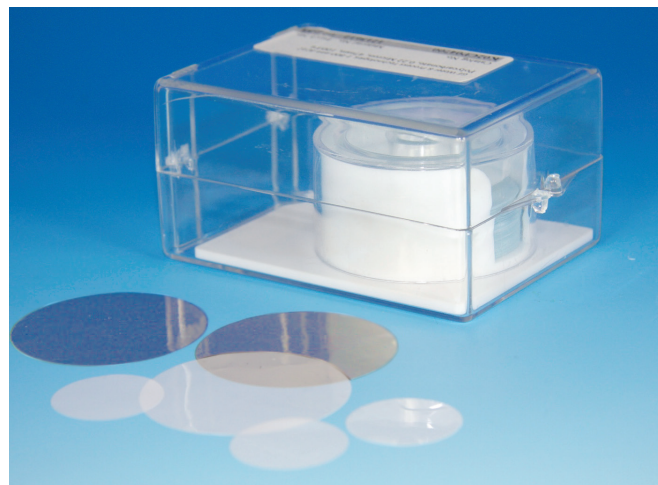

### Features

- Surface retention
- Precise pore sizes
- Biologically inert
- Non-staining
- Non-hygroscopic

### Applications

- Microbiology
- Microscopy
- Air analysis

### Specifications

Pore Size (a) [µm]	Pore Density (b) [pores/cm <sup>2</sup> ]	Nominal Thickness (c) [µm]	Min. BubblePoint (d) [psi]	Typical Flow Rate	
				Water (e) [ml/min/cm <sup>2</sup> ]	Air [l/min/cm <sup>2</sup> ]
20	4 x 10 <sup>4</sup>	3	1	1000	11 (g)
14	5 x 10 <sup>4</sup>	6	0.2	1400	63.5 (g)
12	1 x 10 <sup>5</sup>	8	0.4	1250	83.5 (g)
10	1 x 10 <sup>5</sup>	10	0.5	1150	34.5 (g)
8	1 x 10 <sup>5</sup>	7	0.7	1000	30 (g)
5	4 x 10 <sup>5</sup>	10	1.2	700	30 (g)
3	2 x 10 <sup>6</sup>	9	2	440	37.5 (g)
2	2 x 10 <sup>6</sup>	10	3	300	16.5 (f)
1	2 x 10 <sup>7</sup>	11	6	130	20 (f)
0.8	3 x 10 <sup>7</sup>	9	7	90	18 (f)
0.6	3 x 10 <sup>7</sup>	9	9	60	7.5 (f)
0.4	1 x 10 <sup>8</sup>	10	12	33	7.5 (f)
0.2	3 x 10 <sup>8</sup>	10	20	10	3 (f)
0.1	4 x 10 <sup>8</sup>	6	30	2.2	1.5 (f)
0.08	4 x 10 <sup>8</sup>	6	38	0.6	0.75 (f)
0.05	6 x 10 <sup>8</sup>	6	50	0.4	0.37 (f)
0.03	6 x 10 <sup>8</sup>	6	NA	0.2	0.075 (f)
0.01	6 x 10 <sup>8</sup>	6	NA	0.1	0.0075 (f)

### Notes:

(a) Tolerance +0% - 20%

(b) Tolerance +/- 15%

(c) Tolerance +/- 10%

(d) Measured using Isopropanol

(e) Initial flow rates using prefiltered water at 10 psid (0.7 kg/cm<sup>2</sup>)

(f) initial flow rates using prefiltered air at 10 psid (0.7 kg/cm<sup>2</sup>)

(g) initial flow rates using prefiltered air at 5 psid (0.35 kg/cm<sup>2</sup>)



## MontaMil® Polycarbonate Membrane Filters

### Ordering information

Pore Size [µm]	Diameter [mm]	Colour	Packing [pcs.]	Cat. No.
20	25	white	100	K22CP02500
20	47	white	100	K22CP04700
14	25	white	100	K14CP02500
14	47	white	100	K14CP04700
12	25	white	100	K12CP02500
12	47	white	100	K12CP04700
10	25	white	100	K99CP02500
10	47	white	100	K99CP04700
8	25	white	100	K80CP02500
8	25	black	100	K80BP02500
8	47	white	100	K80CP04700
5	25	white	100	K50CP02500
5	25	black	100	K50BP02500
5	47	white	100	K50CP04700
5	47	black	100	K50BP04700
3	25	white	100	K30CP02500
3	25	black	100	K30BP02500
3	47	white	100	K30CP04700
3	47	black	100	K30BP04700
2	25	white	100	K20CP02500
2	25	black	100	K20BP02500
2	47	white	100	K20CP04700
1	25	white	100	K10CP02500
1	25	black	100	K10BP02500
1	47	white	100	K10CP04700
1	47	black	100	K10BP04700
0.8	25	white	100	K08CP02500
0.8	25	black	100	K08BP02500
0.8	47	white	100	K08CP04700
0.8	47	black	100	K08BP04700
0.6	25	white	100	K06CP02500
0.6	25	black	100	K06BP02500
0.6	47	white	100	K06CP04700
0.6	47	black	100	K06BP04700
0.4	25	white	100	K04CP02500
0.4	25	black	100	K04BP02500
0.4	47	white	100	K04CP04700
0.4	47	black	100	K04BP04700
0.2	25	white	100	K02CP02500
0.2	25	black	100	K02BP02500
0.2	47	white	100	K02CP04700
0.2	47	black	100	K02BP04700
0.1	25	white	100	K01CP02500
0.1	25	black	100	K01BP02500
0.1	47	white	100	K01CP04700
0.1	47	black	100	K01BP04700
0.08	25	white	100	KN8CP02500
0.08	47	white	100	KN8CP04700
0.05	25	white	100	KN5CP02500
0.05	47	white	100	KN5CP04700
0.03	25	white	100	KN3CP02500
0.03	47	white	100	KN3CP04700
0.01	25	white	100	KN1CP02500
0.01	47	white	100	KN1CP04700

# MEMBRANE FILTERS

## MontaMil® MCE Membrane Filters – Sterile

- Mixed Cellulose Ester (MCE) is a mixture of Cellulose Nitrate and Cellulose Acetate. By adding Cellulose Acetate the surface of the membrane becomes smoother and more uniform than pure Cellulose Nitrate.
- White membranes with black grids.
- Diameter 47 mm.
- Pore sizes 0.22 µm and 0.45 µm.
- Membranes are manufactured in accordance with ISO 9001 and comply with ISO 7704.



### Features

- High porosity
- High purity – Triton-free
- Biological inert

### Applications

- Microbiological control of water, beverages, pharmaceuticals

## Sterile MCE white gridded

Pore Size [µm]	Diameter [mm]	Packing [pcs.]	Cat. No.
0.22	47	100	MCEWGS047022
0.45	47	100	MCEWGS047045

## Filter Cassettes

- For transport and storage of filters
- Made of antistatic material
- Tight lid which prevent contamination
- Filters are kept in place along the edge of the filters
- Three sizes – for 25 mm, 37 mm and 47 mm filters



### Ordering information

For filter diameter [mm]	Packing [pcs.]	Cat. No.
25	25	L90025
37	25	L90037
47	25	L90047

# QUALITATIVE FILTER PAPERS

## Qualitative Filter Papers





- Extremely pure filter paper made from almost 100% alpha cotton cellulose.
- Ash content approx. 0.06%.
- Four types with different filtration speed and retention characteristics available.
- Available as plain circles and pre-pleated ready to use.
- Boxes are clearly labeled with colour code, type, grade, filtration characteristics and retention efficiency.



### Applications





- Clarify and remove precipitates
- Preparation for qualitative analysis

### Specifications

Grade	Retention [ $\mu\text{m}$ ]	Weight [ $\text{g}/\text{m}^2$ ]	Thickness [mm]	Filtration speed [sec.]*
 <b>204</b>	12-15	80	0.16	10 (fast)
 <b>201</b>	8-12	80	0.16	20 (medium/fast)
 <b>202</b>	5-8	87	0.16	50 (medium)
 <b>205</b>	2-3	80	0.14	180 (slow)





\*According to DIN 53137

### Plain circles

 <b>Grade 204</b>		 <b>Grade 201</b>		 <b>Grade 202</b>		 <b>Grade 205</b>	
Diam. [mm]	Cat. No.	Diam. [mm]	Cat. No.	Diam. [mm]	Cat. No.	Diam. [mm]	Cat. No.
55	204.055	55	201.055	55	202.055	55	205.055
70	204.070	70	201.070	70	202.070	70	205.070
90	204.090	90	201.090	90	202.090	90	205.090
110	204.110	110	201.110	110	202.110	110	205.110
125	204.125	125	201.125	125	202.125	125	205.125
150	204.150	150	201.150	150	202.150	150	205.150
185	204.185	185	201.185	185	202.185	185	205.185
240	204.240	240	201.240	240	202.240	240	205.240
270	204.270	270	201.270	270	202.270	270	205.270

Packing: 100 pcs. pr. box

### Pleated

 <b>Grade 204F</b>		 <b>Grade 201F</b>		 <b>Grade 202F</b>		 <b>Grade 205F</b>	
Diam. [mm]	Cat. No.	Diam. [mm]	Cat. No.	Diam. [mm]	Cat. No.	Diam. [mm]	Cat. No.
110	204F.110	110	201F.110	110	202F.110	110	205F.110
125	204F.125	125	201F.125	125	202F.125	125	205F.125
150	204F.150	150	201F.150	150	202F.150	150	205F.150
185	204F.185	185	201F.185	185	202F.185	185	205F.185
240	204F.240	240	201F.240	240	202F.240	240	205F.240
320	204F.320	320	201F.320	320	202F.320	320	205F.320

Packing: 100 pcs. pr. box

## Quantitative Filter Papers

- Quantitative (ashless) filter papers are made from 100% cotton linters and are free from impurities since the paper is acid washed and cleaned with ultra pure water.
- The ash content is 0.007%.
- Four types with different filtration speed and retention characteristics.
- Available as plain circles and pre-pleated ready to use.
- Boxes are clearly labeled with colour code, type, grade, filtration characteristics and retention efficiency.



### Applications

- Environmental analysis
- Gravimetric analysis

### Specifications

Grade	Retention [ $\mu\text{m}$ ]	Weight [ $\text{g}/\text{m}^2$ ]	Thickness [mm]	Filtration speed [sec.]*
● 441	12-15	84	0.18	10 (fast)
● 442	8-12	84	0.17	20 (medium/fast)
● 440	5-8	84	0.16	50 (medium)
● 444	2-3	84	0.14	180 (slow)

\*According to DIN 53137

### Plain circles

● Grade 441		● Grade 442		● Grade 440		● Grade 444	
Diam. [mm]	Cat. No.	Diam. [mm]	Cat. No.	Diam. [mm]	Cat. No.	Diam. [mm]	Cat. No.
55	441.055	55	442.055	55	440.055	55	444.055
70	441.070	70	442.070	70	440.070	70	444.070
90	441.090	90	442.090	90	440.090	90	444.090
110	441.110	110	442.110	110	440.110	110	444.110
125	441.125	125	442.125	125	440.125	125	444.125
150	441.150	150	442.150	150	440.150	150	444.150
185	441.185	185	442.185	185	440.185	185	444.185
240	441.240	240	442.240	240	440.240	240	444.240
270	441.270	270	442.270	270	440.270	270	444.270

Packing: 100 pcs. pr. box

### Pleated

● Grade 441F		● Grade 442F		● Grade 440F		● Grade 444F	
Diam. [mm]	Cat. No.	Diam. [mm]	Cat. No.	Diam. [mm]	Cat. No.	Diam. [mm]	Cat. No.
110	441F.110	110	442F.110	110	440F.110	110	444F.110
125	441F.125	125	442F.125	125	440F.125	125	444F.125
150	441F.150	150	442F.150	150	440F.150	150	444F.150
185	441F.185	185	442F.185	185	440F.185	185	444F.185
240	441F.240	240	442F.240	240	440F.240	240	444F.240
320	441F.320	320	442F.320	320	440F.320	320	444F.320

Packing: 100 pcs. pr. box

# GLASS FIBER FILTERS

## Glass Fiber Filters

- Glass fiber filters are made of 100% borosilicate glass without binder.
- Resist temperatures up to 500°C, have a good chemical resistance and are biological inert.
- Compared with filter papers glass fiber filters offer a high loading capacity, faster filtration speed and a more efficient filtration.
- Glass fiber filters should be used flat.



### Specifications and application examples

Grade	Retention <sup>1</sup> [µm]	Weight [g/m <sup>2</sup> ]	Thickness [mm]	Filtration speed <sup>2</sup> [sec.]	Application examples
<b>GA</b>	1.6	52	0.26	60	Air analysis. Suspended solids in waste water according to EN872:2005
<b>GB</b>	1.0	143	0.70	200	Thick filter with good retention of difficult-to-filter suspensions
<b>GC</b>	1.2	52	0.26	100	Suspended solids in waste water according to EN872:2005. Cell harvesting
<b>GD</b>	2.7	120	0.53	30	Ideal as pre-filter for membranes
<b>GF</b>	0.7	75	0.45	310	Collection of fine proteins and algae
<b>GH</b>	1.5	65	0.28	60	Suspended solids in waste water

1) Approx. 98% of particles with the stated size will be retained by the filter

2) According to Herzberg

### Ordering information

Dia- meter/ [mm]	GA		GB		GC		GD		GF		GH	
	Packing	Cat. No.	Packing	Cat. No.	Packing	Cat. No.	Packing	Cat. No.	Packing	Cat. No.	Packing	Cat. No.
25	100	GA.025	50	GB.025	100	GC.025	50	GD.025	100	GF.025	100	GH.025
37	100	GA.037	50	GB.037	100	GC.037	50	GD.037	100	GF.037	100	GH.037
47	100	GA.047	50	GB.047	100	GC.047	50	GD.047	100	GF.047	100	GH.047
55	100	GA.055	50	GB.055	100	GC.055	50	GD.055	100	GF.055	100	GH.055
70	100	GA.070	50	GB.070	100	GC.070	50	GD.070	100	GF.070	100	GH.070
90	100	GA.090	50	GB.090	100	GC.090	50	GD.090	50	GF.090	100	GH.090
110	100	GA.110	25	GB.110	100	GC.110	25	GD.110	50	GF.110	100	GH.110
125	100	GA.125	25	GB.125	100	GC.125	25	GD.125	50	GF.125	100	GH.125
150	100	GA.150	25	GB.150	100	GC.150	25	GD.150	50	GF.150	100	GH.150



## Quartz Fiber Filters

- Quartz Fiber Filters are made of 100% pure quartz and are binder-free.
- Quartz has an excellent temperature resistance, up to 900°C, and has low content of trace elements.

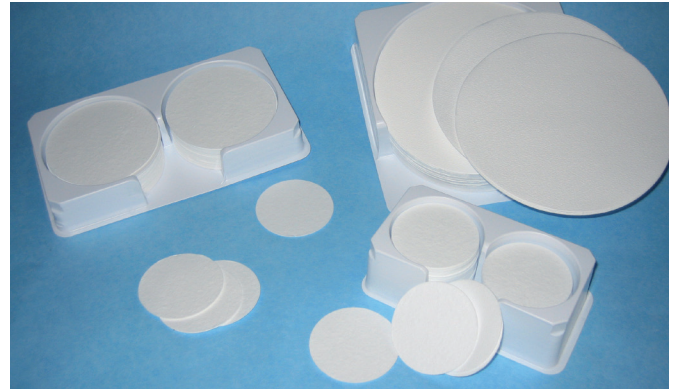

### Applications

- Emission control
- Exhaust gas control
- Air pollution analysis

### Specifications

Type	Weight [g/m <sup>2</sup> ]	Retention efficiency [%] 0,3 µm DOP
QF	85	99.998

### Trace Elements, typical values [ppm]

Al	As	Cd	Co	Cr	Cu	Fe	Hg	Mg	Mn	Na	Ni	Pb	Sb	Sn	Ti	V	Zn
50	0.75	1.5	1	5	1.25	30	<0.05	25	1.25	40	2	0.75	1.25	0.5	2.5	0.5	5

### Ordering information

Diameter / size [mm]	Packing [pcs.]	Cat. No.
25	50	QF.025
37	50	QF.037
45	50	QF.045
47	50	QF.047
55	50	QF.055
70	50	QF.070
80	50	QF.080
85	50	QF.085
90	50	QF.090
110	50	QF.110
118	50	QF.118
150	50	QF.150
203 x 254	25	QF.203254

# FILTER HOLDERS

## Glass Filter Holders – 25 mm

- For 25 mm filters. Made of borosilicate glass.
- Choose between sintered glass support and stainless steel support.
- **Sintered glass support** for microbiological and particle analysis. Model 25-SG.
- **Stainless steel support** for producing a clean filtrate and for filtration of solutions containing proteins. Model 25-SS.
- Funnel capacity is 22 ml. Graduated to 15 ml.
- Holders are supplied complete with funnel, base, clamp and silicone stopper.

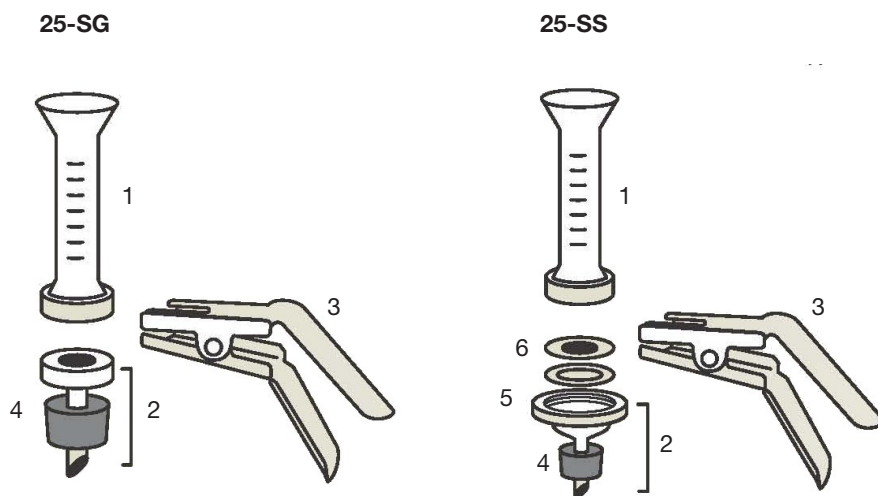

### Ordering information

Model	25-SG	25-SS
Cat. No.	258100	259100

Spare Parts	25-SG	25-SS
1 Funnel	257101	257101
2 Base incl. stopper	257102	257103
3 Clamp	257104	257104
4 Stopper No. 5	257105	257105
5 PTFE gasket	-	257106
6 Stainless steel screen	-	257107

## Glass Filter Holders – 47 mm

- For 47 mm filters. Made of borosilicate glass.
- Choose between sintered glass support and stainless steel support.
- **Sintered glass support** for microbiological and particle analysis. Model 47-SG.
- **Stainless steel support** for producing a clean filtrate and for filtration of solutions containing proteins. Model 47-SS.
- Funnel capacity is 300 ml. Graduated to 250 ml.
- Holders are supplied complete with funnel, base, clamp and silicone stopper.



47-SG

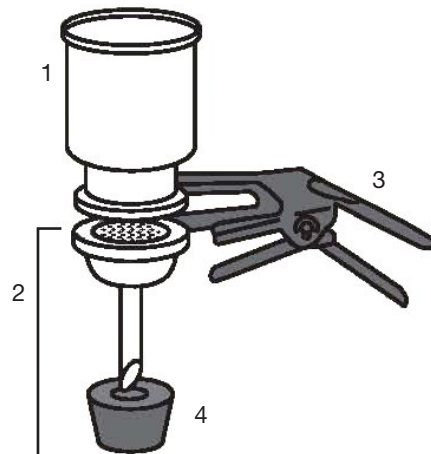

47-SS

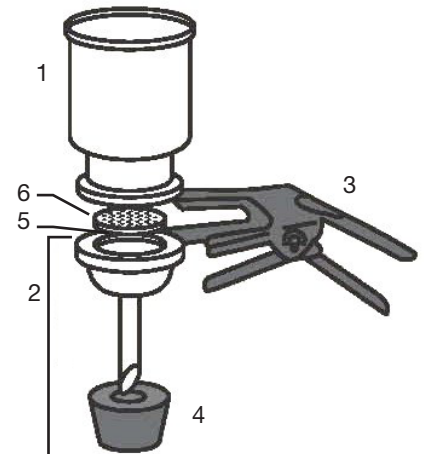

### Ordering information

Model	47-SG	47-SS
Cat. No.	478100	479100

Spare Parts	47-SG	47-SS
1 Funnel	477101	477101
2 Base incl. stopper	477102	477103
3 Clamp	477104	477104
4 Stopper No. 8	477105	477105
5 PTFE gasket	-	477106
6 Stainless steel screen	-	477107

# EXTRACTION THIMBLES

## Extraction Thimbles

- Cellulose extraction thimbles made of pure cotton linters completely free from impurities and are fat free.
- Thimbles hold solid material from which certain substances are eluted e.g. fat from foodstuffs.
- Dimensions are inside diameter x length.
- Standard wall thickness is approx. 1.5 mm.

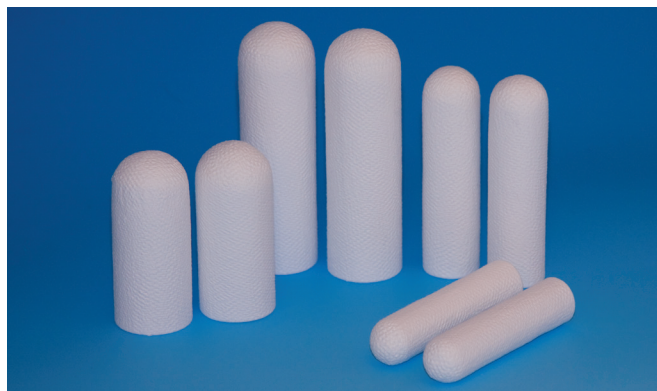

- Soxhlet extractions
- Dust sampling

### Ordering information

Size [mm]	Packing [pcs.]	Cat. No.
19 x 90	25	610.199
22 x 80	25	610.228
25 x 80	25	610.258
25 x 100	25	610.250
26 x 60	25	610.266
28 x 80	25	610.288
28 x 100	25	610.280
30 x 80	25	610.308
30 x 100	25	610.300
33 x 80	25	610.338
33 x 94	25	610.339
33 x 100	25	610.331
33 x 118	25	610.318
35 x 150	25	610.351
41 x 123	25	610.412

## Lens Cleaning Tissue

- Very soft paper made of 100% Manilla fibers.
- No fluffy and do not scratch.
- Packed in cardboard boxes.
- Sheets size 135 x 170 mm.

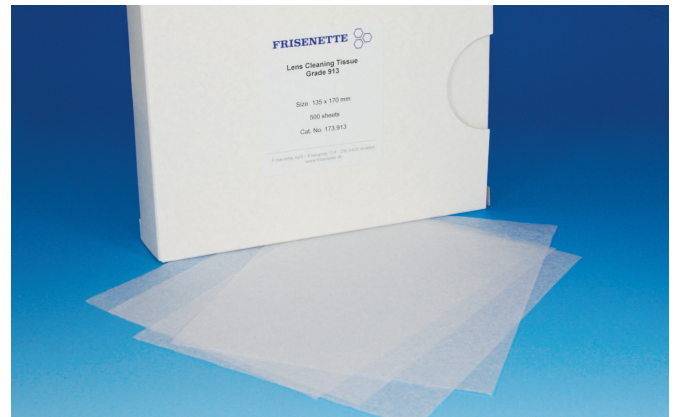

### Ordering information

Packing [pcs.]	Cat. No.
500	173.913

## Weighing Paper

- Very smooth 40 g/m<sup>2</sup> paper. The smooth surface ensures excellent dispensing of powders.
- Packed in cardboard boxes.
- Available in two sizes.

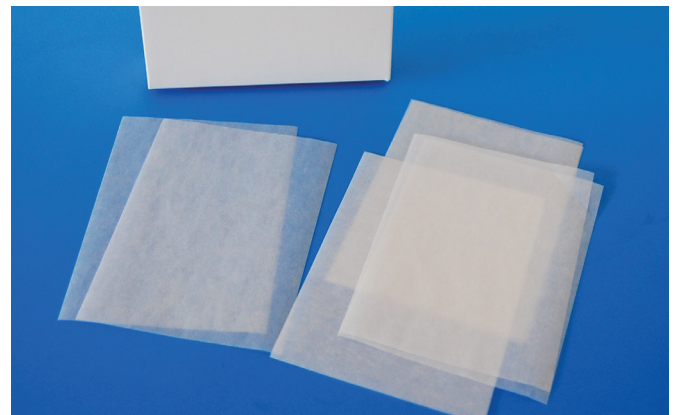

### Ordering information

Size [mm]	Packing [pcs.]	Cat. No.
100 x 100	500	171.100100
90 x 125	500	171.925

## Milk Sediment Filters

- Used for checking for impurities in raw milk.



### Ordering information

Diameter [mm]	Packing [pcs.]	Cat. No.
32	500	133.032



# SEED TESTING PAPERS

## Seed Testing Papers

- For germination tests.
- Available as circles, circles with a slit for wick and sheets.
- The paper has a thickness of approx. 0.3 mm. and a weight of approx. 140 g/m<sup>2</sup>.
- Standard sizes for circles are 75 mm and 85 mm.
- Standard size for wicks is 18 x 310 mm.
- Standard sizes for sheets are 48 x 48 cm and 62 x 62 cm.
- Special cuts available on request.

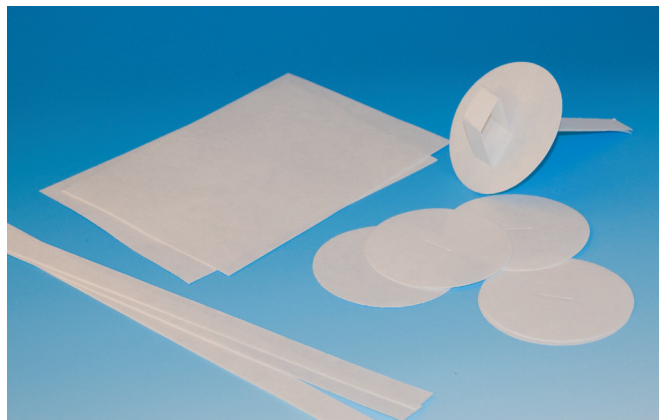

### Circles

Diameter [mm]	Packing [pcs.]	Cat. No.
75	5.000	127.075
85	5.000	127.085

### Circles – with slit for wick

Diameter [mm]	Packing [pcs.]	Cat. No.
75	5.000	127.175
85	5.000	127.185

### Wicks

Diameter [mm]	Packing [pcs.]	Cat. No.
18 x 310	2.500	127.018310

### Sheets

Size [mm]	Packing [pcs.]	Cat. No.
480 x 480	500	124.948
620 x 620	500	124.962



## pH Test Paper and Test Strips

### pH Test Paper

- Fast and easy measurements of pH value in liquids.
- Available as universal types which cover a large area of the pH range and types which give a more precise measurement of the pH value.
- Dip a piece of suitable length of the indicator paper in the liquid for a few seconds and compare with the colour scale.
- pH Test Papers are available as rolls with a length of 5 m in a plastic dispenser. Colour scale included.



### Specifications

pH range	pH graduations												Cat. No.
1 – 14	1	2	3	4	5	6	7	8	9	10	12	14	91135
0 – 10	0	1	2	3	4	5	6	7	8	9	10	91134	
1 – 11	1	2	3	4	5	6	7	8	9	10	11	91124	
0.5 – 5	0.5	1	1.5	2	2.5	3	3.5	4	4.5	5	91130		
5 – 9	5	5.5	6	6.5	7	7.5	8	8.5	9	91131			
6.5 – 10	6.5	7	7.5	8	8.5	9	9.5	10	91132				
9 – 13	9	9.5	10	10.5	11	11.5	12	12.5	13	91133			
4 – 7	4	4.3	4.6	4.9	5.2	5.5	5.8	6.1	6.4	6.7	7	91138	
6.4 – 8	6.4	6.7	7	7.2	7.4	7.7	8	91140					

### pH Test Strips

- Fast and easy measurements of pH value in liquids.
- Available as a universal type which covers the full pH range and types which give a more precise measurement of the pH value.
- Dip the indicator strip in the liquid for a few seconds and compare with the colour scale.
- Plastic box with 100 strips and colour scale.



### Specifications

pH range	pH graduations												Cat. No.			
0 – 14	0	1	2	3	4	5	6	7	8	9	10	11	12	13	14	101021
0.5 – 5	0.5	1	1.5	2	2.5	3	3.5	4	4.5	5	101023					
5.5 – 9	5.5	6	6.5	7	7.5	8	8.5	9	101024							
9.5 – 13	9.5	10	10.5	11	11.5	12	12.5	13	101025							



4th issue

**FRISENETTE**

