

# Vortex Mixer 2800 rpm



## AHN myLab VT-02



Instruction Manual



# TABLE OF CONTENTS

|   |           |
|---|-----------|
| <b>1. Product Description.....</b>                          | <b>1</b>  |
| 1.1 Introduction  |           |
| 1.2 Intended Use  |           |
| 1.3 Features  |           |
| 1.4 Technical Specifications                                |           |
| 1.5 Accessories   |           |
| <b>2. Safety Precautions.....</b>                           | <b>2</b>  |
| <b>3. Installation.....</b>                                 | <b>3</b>  |
| 3.1 Location  |           |
| 3.2 Connecting Power Adaptor                                |           |
| <b>4. Standard Parts Listing.....</b>                       | <b>4</b>  |
| <b>5. User Interface and Display.....</b>                   | <b>5</b>  |
| <b>6. Optional Attachments &amp; Their Installment.....</b> | <b>6</b>  |
| <b>7. Operation.....</b>                                    | <b>10</b> |
| 7.1 Connecting Power Adaptor                                |           |
| 7.2 Setting Speed and Time                                  |           |
| 7.3 Standby, Touch & Continuous Mode                        |           |
| 7.4 Touch Mode Operation                                    |           |
| 7.5 Continuous Mode Operation                               |           |
| <b>8. Maintenance and Cleaning.....</b>                     | <b>13</b> |
| <b>9. Warranty Statement.....</b>                           | <b>14</b> |
| <b>10. Product Disposal.....</b>                            | <b>15</b> |

# 1. PRODUCT DESCRIPTION

## 1.1 INTRODUCTION

This Vortex Mixer is designed for laboratory mixing. It assures the highest performance in terms of speed, reliability, precision and safety. The Vortex Mixer has a variable speed with digital control that allows to start with low RPM for gentle shaking and high speed mixing for vigorous vortexing of samples.

## 1.2 INTENDED USE

This Vortex Mixer is a general laboratory Vortex Mixer. It is intended for applications where vortexing of single or multiple tubes is required.

## 1.3 FEATURES

1. Continuous & touch operation
2. Adjustable speed ranging up to 2800 RPM
3. Long life Brushless DC motor with ball bearing
4. Inbuilt counter balance for steady and safe operation
5. Orbital diameter of 4 mm
6. Broad range of accessories (optional)
7. Robust construction for stable operation
8. Silent operation
9. Universal power supply
10. Broad range of accessories available

## 1.4 TECHNICAL SPECIFICATIONS

|                        |                         |
|------------------------|-------------------------|
| Orbital Diameter       | 4 mm                    |
| Maximum Speed          | 2800 RPM                |
| Speed Accuracy         | ± 5%                    |
| Maximum Load Capacity  | 500 gm                  |
| Different modes        | Continuous & Touch mode |
| Protection Rating      | IP21                    |
| Ambient Temperature    | 5 to 40 °C              |
| Dimensions (W x D x H) | 205 x 138.5 x 136 mm    |
| Weight                 | 3 Kg                    |
| Power Supply           | 220 - 240VAC, 50Hz      |
| Power Consumption      | 70 W                    |

## 1.5 ACCESSORIES

1. Standard cup head (pre-installed), Rubber disk attachment
2. Product user manual & warranty card
3. Universal attachments plus microplate, Round disk attachment, microtube foam & Flask rubber attachments (optional)

## 2. SAFETY PRECAUTIONS

1. Do not use the unit if it shows any sign of electrical or mechanical damage.
2. Do not use the Vortex Mixer in hazardous atmosphere or with hazardous material for which the unit is not designed.
3. Always use the Vortex Mixer on a levelled & stable surface for best performance and maximum safety.
4. Do not the lift the Vortex Mixer with the attachments, as every attachment including the cup head are designed to be pulled off for interchanging.
5. Do not rotate or give full rotation to the attachments (cup head,

universal attachment, etc) attached to the modified shaft body.

6. Clean the unit with a damp cloth using a mild detergent only. Do not use chemical cleaning agents.
7. If liquid is spilled on the unit, first disconnect the unit from the external (main) power supply and then clean the unit with a damp cloth.
8. Do not use accessories which are not recommended by the manufacture as it may affect the performance.
9. The instrument is designed to be used in the laboratory environment.
10. Liquid spillage may harm the unit. Do not fill microtubes, microplates or flasks while they are attached to the Vortex Mixer.
11. Refer to the recommended maximum speed for specific attachments for safe usage. (Refer table on page: 7)

### **3. INSTALLATION**

Open the box, open the inner packaging and gently take the Vortex Mixer out of the box. Before the first use ensure that all the packaging is removed and the cup head is firmly tightened before using the product. The user manual and accessories should be kept near the unit for at least two years for warranty purposes.

#### **3.1 LOCATION**

Take the unit out and place it on the levelled & stable surface near the grounded electrical outlet. The surface should be clean and free from dust to ensure that the feet grip the surface firmly. Keep clearance off 10 cm on all sides of the unit for proper ventilation.

Keep the unit away from heat & direct sunlight to avoid sample temperature issues.

### 3.2 CONNECTING THE POWER ADAPTOR

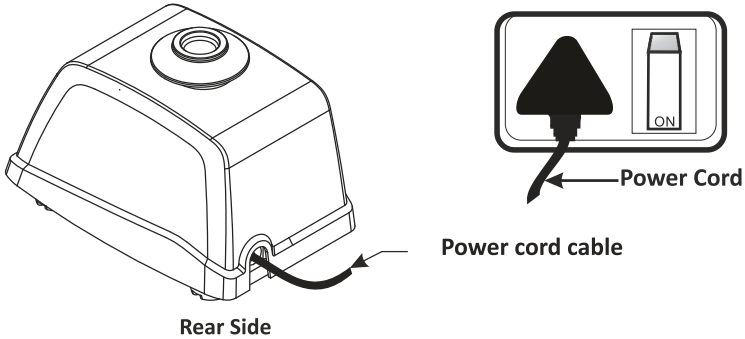

Connect one end of the power adaptor pin to the rear side of the unit and another end to the main supply as shown in the figure above. Make sure that the main switch is not switched “ON” until the adaptor is connected to both sides.

For the desktop adaptor, make sure that the power adaptor and power cord are connected properly before connecting to the main power supply and the unit.

## 4. STANDARD PART LISTING

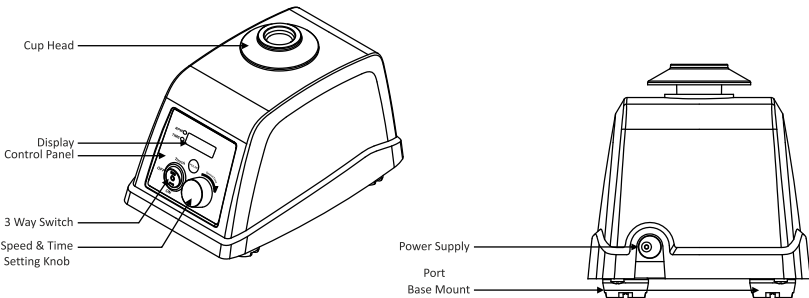

## 5. USER INTERFACE & DISPLAY

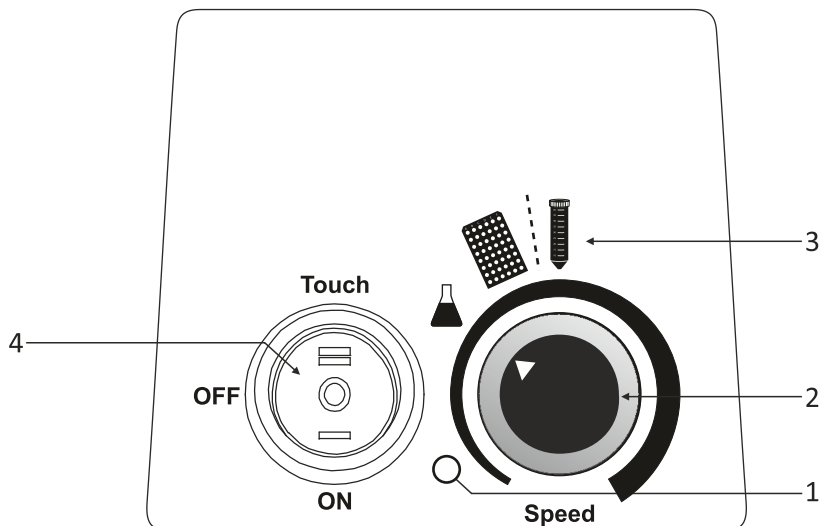

| No. | Name/Symbol                                   | Function  |
|-----|---|---|
| 1   | Power LED                                     | Power Led showing the status of vortex action. Glowing - when vortex action is in process, Not Glowing - No vortex action |
| 2   | Speed   | Speed setting knob to set different speed. Rotate clockwise to increase & counter-clockwise to decrease speed value.      |
| 3   | Max. Speed Indication for Specific Attachment | Attachments position with reference to speed setting knob for Max. allowed speed indication.                              |
| 4   | 3 Way Switch (Mode selection)                 | Rocker switch is used to select different modes of the Vortex Mixer. OFF (stand by), Continuous & Touch Operation Mode.   |



## 6. OPTIONAL ATTACHMENTS & THEIR INSTALLMENT

The standard attachment is normally used for vortexing samples in tubes. The Vortex Mixer can accommodate optional attachments when combined with the optional universal attachment. Optional attachments include the universal attachment, which can combine with other foam attachments and can be used for mixing samples in microplates, microtubes & flasks.

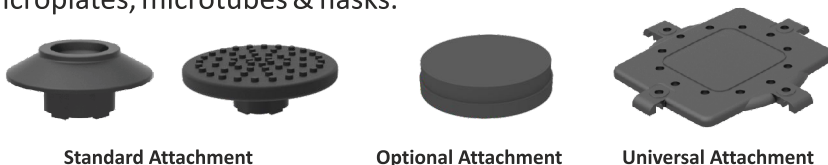

The additional foam attachments below along with the universal attachment can be used for mixing samples in microplates & microtubes (1.5/2.0ml). First attach the universal attachment, place the tubes in the foam sheet & then combine it with the universal attachment.

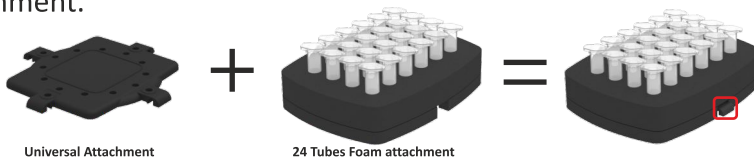

**Note:** The microtube foam attachment can be operated with maximum speed of microplate indication. Product sticker with the fill not more than 75% of sample. Do not fill tubes while they are in foam attachment, liquid spillage might harm the attachment or unit.

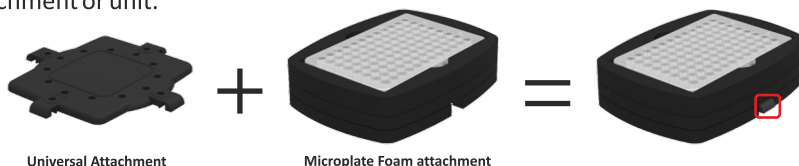

**Note:** The Microplate foam attachment can be operated with maximum speed of Microplate Indication. Product sticker with the fill not more than 75% of well of microplate. Do not fill microplate while they are in foam attachment, liquid spillage might harm the attachment or unit.

The additional rubber attachments below when in combination with the universal attachment can be used for mixing samples in 250ml flask. First always attach the universal attachment, then place the flask on the universal attachment & tighten it with the rubber attachment firmly as shown in the figure below.



To tighten the flask, place the rubber attachment as shown in the figure above and lock it with the universal attachment by stretching the rubber attachment.

**Note:** The 250ml flask used with this rubber attachment can be operated with maximum speed as indicated by knob marking. Be careful this might have the use or damage the unit while attaching or filling the flask with the sample to avoid liquid spillage.

| Max. Recommended Speed Table     |       |           |                        |
|----------------------------------|-------|-----------|------------------------|
| Attachments                      | Image | Max. Fill | As Show ON The Sticker |
| Microtubes<br>Foam<br>Attachment |       | 75%       |                        |
| Microplate<br>Foam<br>Attachment |       | 75%       |                        |
| Flask Rubber<br>Attachment       |       | 250ml     |                        |

To remove the standard attachment, pull the standard attachment up with one hand as shown in the figure below. To attach, place the standard attachment on the modified shaft body & center press the attachment as shown in the figure below until it snaps in place. Ensure

that it is attached firmly with the modified shaft body.

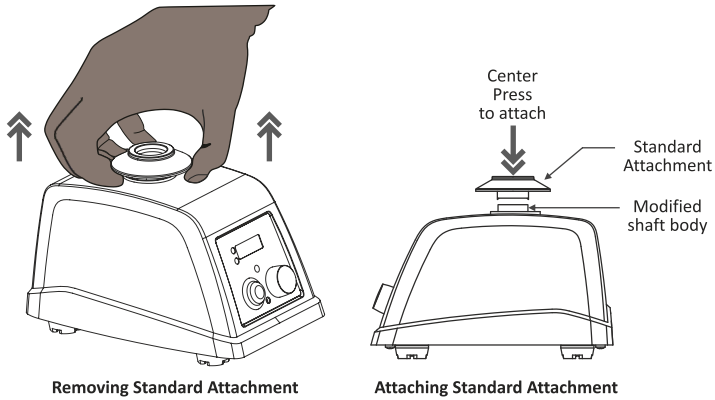

**Note:** Do not rotate the universal attachment or any attachments attached to the modified shaft body.

To remove the universal attachment, pull the universal attachment up with both hands as shown in the figure below. To attach, place the universal attachment on modified body shaft & center press the attachment as shown in the figure below until it snaps into place. Ensure that it is attached firmly to the modified shaft body.

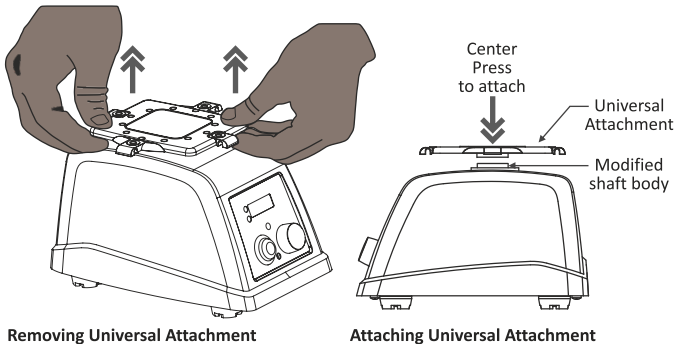

**Note:** Do not rotate standard attachment or any attachments attached to the modified shaft body.

To attach the microtube or microplate foam attachment, first install the universal attachment then place the foam attachment as shown in the image below. Ensure that the foam attachment is securely placed on the universal platform.

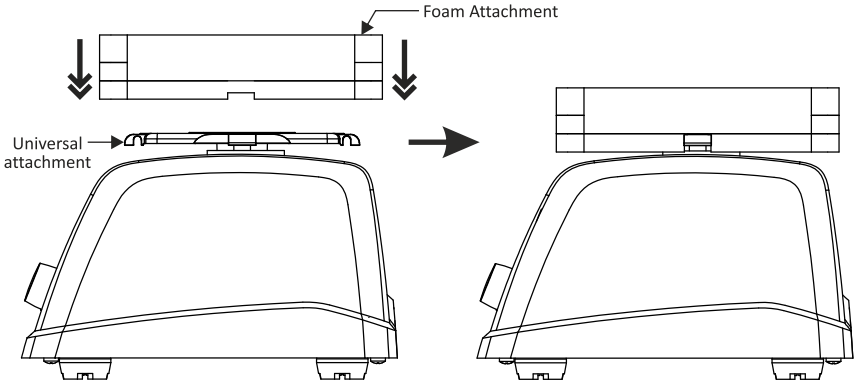

Place the microplate or microtubes first in the foam attachment and then place the foam attachment on the universal attachment attached to the Vortex Mixer.

Inserting filled microplate or microtubes in the foam attachment attached to Vortex Mixer, can lead to spillage of samples.

To attach the flask, first attach the universal attachment then place the flask on it and then tighten / lock with the rubber attachment. Ensure that it is securely placed on the universal platform.

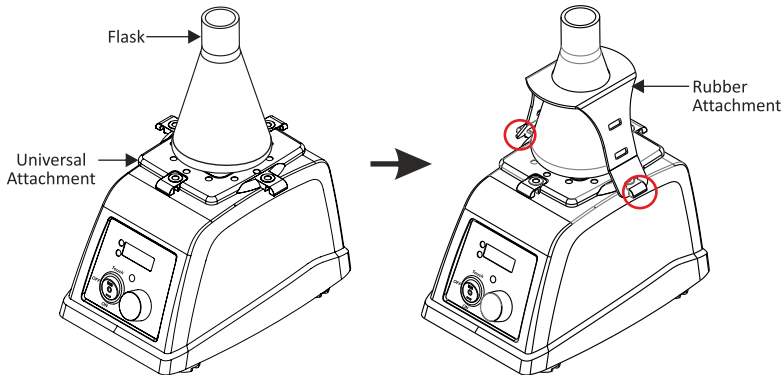

# 7. OPERATION

## 7.1 CONNECTING THE POWER ADAPTOR

Always connect the power adaptor to the unit first & then to the adaptor port. Before connecting to both ends, ensure that the Vortex Mixer is in STANDBY mode and the cup head (attachment) is firmly tightened with the modified shaft body. Below is the image showing the STANDBY mode of the vortex mixer.

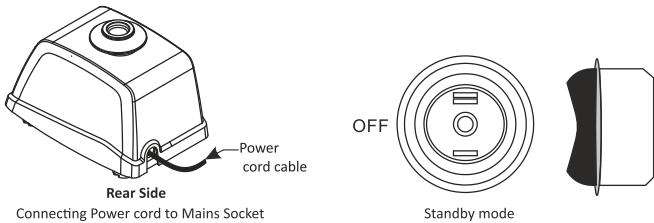

Connect the power adaptor at the rear side of the Vortex Mixer as shown in the image above.

## 7.2 SETTING SPEED

Always set the required speed and time first before doing any mixing operation. Rotate the knob to select and set the speed value. By default, speed will be selected every time the knob rotates. The minimum and maximum speed of the Vortex Mixer is 2800 RPM respectively.

**Note:** Ensure not to use attachment beyond indicator maximum speed.

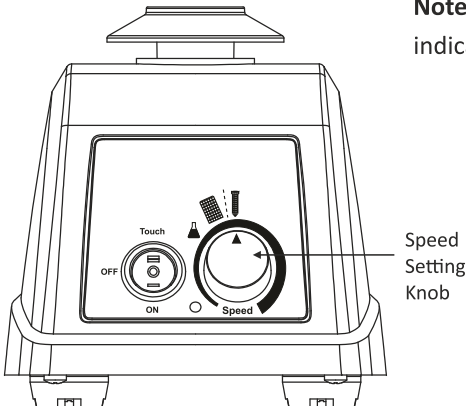

### 7.3 STANDBY, TOUCH & CONTINUOUS MODE

Placing the 3 Way Switch in the STANDBY position. It will keep the Vortex Mixer in an OFF state i.e. it will not operate as TOUCH or CONTINUOUS mode. Below is the position of the 3 Way Switch showing the Vortex Mixer is in STANDBY mode. It is recommended to use STANDBY mode while replacing attachments or when not in use. It is recommended to use STANDBY mode while setting operation parameters.



Press the 3 way switch up towards the “Touch ” side to enable the TOUCH mode. The TOUCH mode is generally used with the standard attachment. In TOUCH mode, vortex action will start only when the cup head is press. Below is the position of the 3 way switch showing the Vortex Mixer is in TOUCH mode.

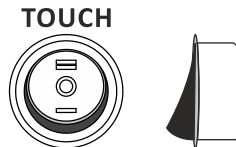

Press the 3 way switch down towards the “ON” side to enable the CONTINUOUS mode. In CONTINUOUS mode, the vortex action will start automatically (without pressing cup head) at the set speed and time. Below is the position of the rocker switch showing the Vortex Mixer in CONTINUOUS mode.



**Note:**

- 1) CONTINUOUS mode is generally used with attachments (refer chart on page7).
- 2) STANDBY mode is generally used while setting parameters or when not in use.

## 7.4 TOUCH MODE OPERATION

Before operating, check that the upper cup head is firmly tightened to the modified shaft body. Set the required speed using the knob in STANDBY mode and select the “TOUCH” mode using the 3 Way Switch. For touch mode operation, gently press and hold the cup head using the tube as long as you want it to run. Release to stop operation. The image below shows the operation in touch mode.

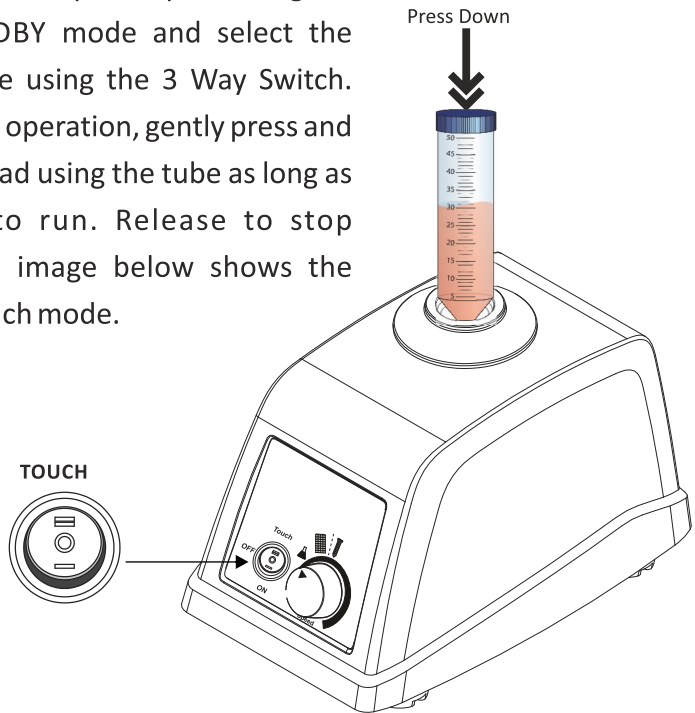

## 7.5 CONTINUOUS MODE OPERATION

Before operation, keep the Vortex Mixer in standby mode and set the operation parameters. Check the attachment you are using is firmly tightened with the modified shaft. Select the “ON” button to start continuous mode operation. The speed value will blink for 3 seconds giving indication of set speed.

In Continuous Mode, the vortex action will start automatically (without pressing the cup head) at set speed and time. In continuous Mode, set RPM & remaining time will be displayed alternatively.

At any time of the continuous mode, the user can modify the speed by rotating the knob and can also modify time by pressing the knob once then rotating it.

For the universal attachment, make sure to fill the liquid or samples before placing the attachments (microtubes foam / microplate foam / flask rubber attachment) on Vortex Mixer.

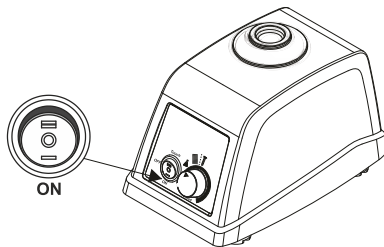

## 8. MAINTENANCE & CLEANING

1. Always keep the Vortex Mixer & its accessories in a safe storage location and clean periodically with moist cloth. After cleaning, ensure that all parts are dry before re-use
2. Ensure that while cleaning the unit is not plugged in.
3. The brushless motor in the Vortex Mixer requires no routine maintenance. Any required service should be performed by authorized, qualified personnel only. Repairs performed by unauthorized personnel may void the warranty.
4. Do not try to pull the Vortex Mixer with attached accessories.
5. Do not try to rotate the attachments attached to modify the shaft body.
6. Do not use the Vortex Mixer & its accessories in direct sunlight or under water.



## 9. WARRANTY STATEMENT

This products is warranted to be free from defects in material and workmanship for a period of two (2) years from date of purchase. Your product will be duly repaired upon prompt notification in compliance with the following conditions :

This warranty is valid only if the product is used for its intended purpose and within the guidelines specified in this instruction manual. This warranty does not cover damage caused by accident, neglect, misuse, improper service, natural forces or other causes not arising from defects in original material or workmanship. This warranty does not cover any incidental or consequential damages, commercial loss or any other damages from the use of this product.

The warranty is invalidated by any non-factory modification, which will immediately terminate all liabilities on us for the products or damages caused by its use. The buyer and its customer shall be responsible for the product or use of products as well as any supervision required for safety. If requested the products must be returned to the distributor in well packed and insured manner and all shipping charges must be paid.

Some states do not allow limitation on the length of implied warranties or the exclusion or limitation of incidental or consequential damages. This warranty gives you specific legal rights. This warranty is given expressly in lieu of all other warranties, expressed or implied.

Products received without proper authorization will not be entertained. All items returned for service should be sent postage prepaid in the original packaging or other suitable carton, padded to avoid damage. We will not be responsible for damage incurred by improper packaging.

All items returned for service should be set postage prepaid in the original packaging or other suitable carton, added to avoid damage.

This warranty is valid only if the warranty is registered with the supplier within 30 days from the date of purchase.

## 10. PRODUCT DISPOSAL

In case the product is to be disposed of, the relevant legal regulations are to be observed.

### **Information on the disposal of electrical and electronic devices in the European Community**

The disposal of electrical devices is regulated within the European Community by national regulations based on EU Directive 2012/19/EU on waste electrical and electronic equipment (WEEE). According to these regulations, any devices supplied after 13.06.05 in the business to business sphere, to which this product is assigned, may no longer be disposed off in municipal or domestic waste. They are marked with the following symbol to indicate this.

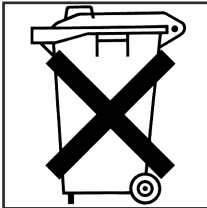

As disposal regulations within the EU may vary from country to country, please contact your supplier if necessary.



ahn®

**AHN Biotechnologie GmbH**

Uthleber Weg 14

D-99734 Nordhausen

Germany

Phone: +49(0)3631/65242-0

Fax: +49(0)3631/65242-90

E-Mail: [info@cappahn.com](mailto:info@cappahn.com)

[www.ahn-bio.de](http://www.ahn-bio.de)

